

ISO line

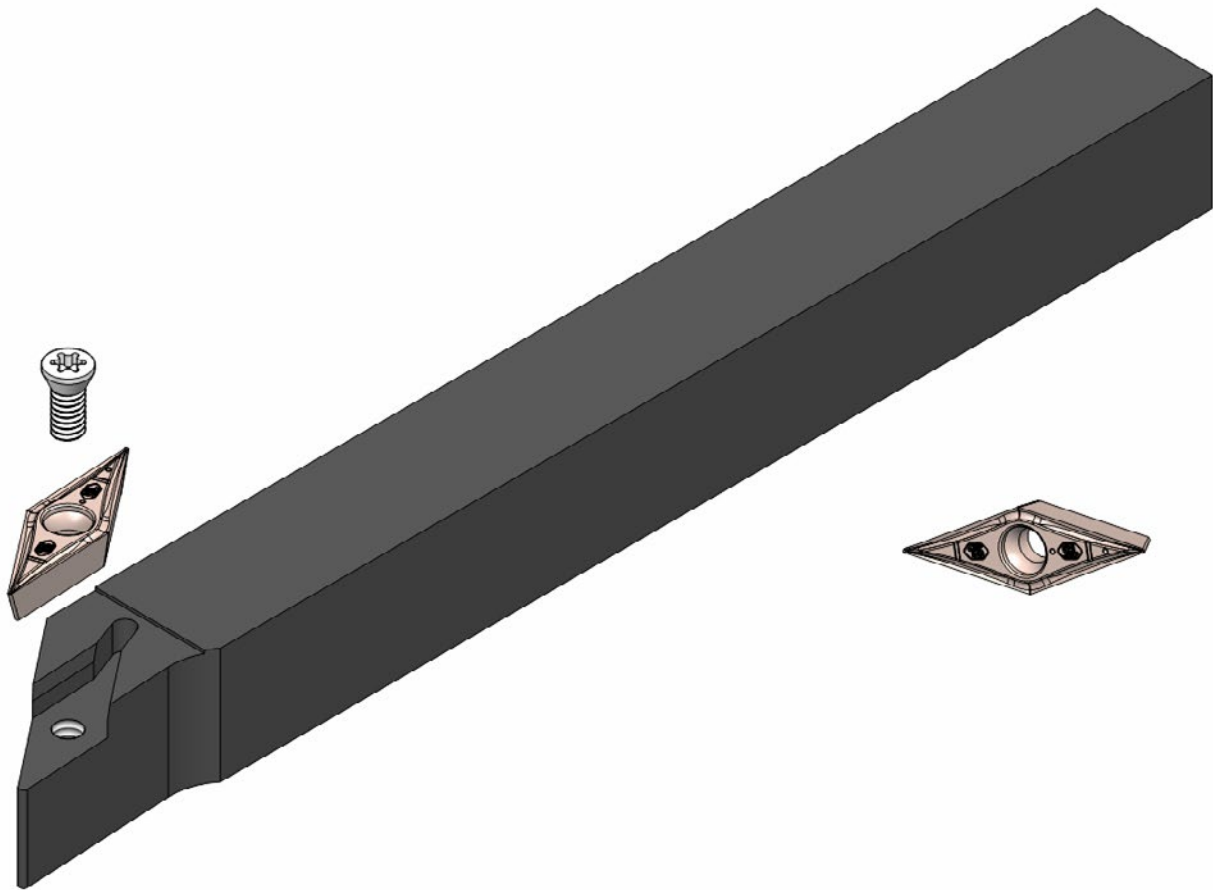



Coating of inserts
Beschichtung der Wendepplatten
Revêtement des plaquettes







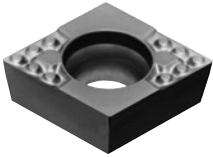
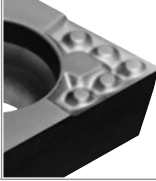
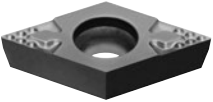
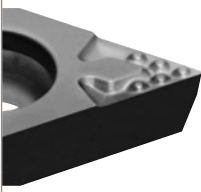

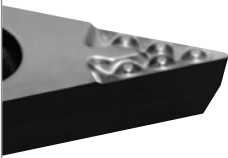
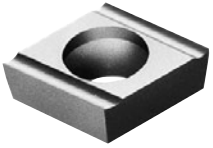
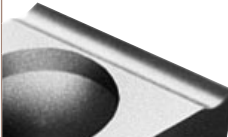
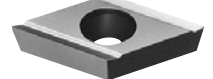
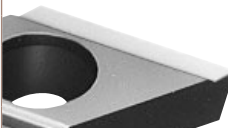

✓ = Available
 ✓ = Verfügbar
 ✓ = Disponible

Designation Bezeichnung Désignation	Description Beschreibung Description
QM2 QM3	TiAlN-based <ul style="list-style-type: none"> • Universal grade for steel, stainless steel and heat-resistant alloys. TiAlN-Basis <ul style="list-style-type: none"> • Universalsorte für Stahl, Edelstahl und hitzebeständige Legierungen. Base TiAlN <ul style="list-style-type: none"> • Qualité universelle pour l'acier, l'acier inoxydable et les alliages résistants à la chaleur.
BI30	AlTiN-based + Micro finish <ul style="list-style-type: none"> • Very sharp cutting edges. • Very smooth surface finish, ideal for non-ferrous materials. AlTiN-Basis + «Micro finish» <ul style="list-style-type: none"> • Sehr scharfe Schneidkanten. • Sehr glatte Oberfläche, ideal für Nichteisenwerkstoffe. Base AlTiN + «Micro finish» <ul style="list-style-type: none"> • Arêtes de coupe très vives. • Bon glissement du copeau, idéal pour les matériaux non ferreux.
BI90	AlTiN-based <ul style="list-style-type: none"> • Universal coating. • Good oxidation resistance. • High heat resistance. • Suitable for steel and stainless steel. AlTiN-Basis <ul style="list-style-type: none"> • Universalbeschichtung. • Gute Oxidationsbeständigkeit. • Hohe Hitzebeständigkeit. • Ideal für Stahl und Edelstahl. Base AlTiN <ul style="list-style-type: none"> • Revêtement universel. • Bonne résistance à l'oxydation. • Haute résistance à la chaleur.. • Adapté à l'acier et à l'acier inox.

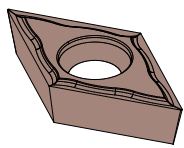
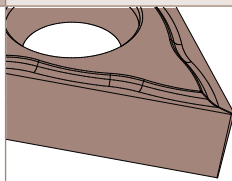
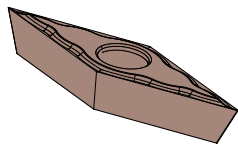
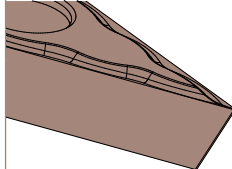

Designation Bezeichnung Désignation	Description Beschreibung Description
BI120	<p>AlCrN-based</p> <ul style="list-style-type: none"> • Optimal for cutting edges subject to heavy wear. • Very high heat resistance. • High coating adhesion. <p>AlCrN-Basis</p> <ul style="list-style-type: none"> • Optimal für stark beanspruchte Schneidkanten. • Sehr hohe Hitzebeständigkeit. • Hohe Schichthaftung. <p>Base AlCrN</p> <ul style="list-style-type: none"> • Optimal pour les arêtes de coupe soumises à une forte usure. • Très haute résistance à la chaleur. • Haute adhérence du revêtement.

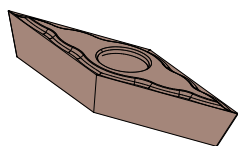
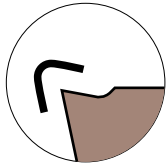
Tool holders with internal coolant Werkzeughalter mit Innenkühlung Porte-outils avec arrosage intégré		
	<p>See the «Tool holders with internal coolan» documentation for further information. Siehe die «Werkzeughalter mit Innenkühlung» Dokumentation für weitere Informationen. Voir la documentation «Porte-outils avec arrosage intégré» pour plus d'informations.</p>	
Turning tool holders for counter-operation Drehwerkzeughalter für Rückseitenbearbeitung Porte-outils de tournage pour contre-opération		
	<p>See the «Cylindrical turning tool holders» documentation for further information. Siehe die «Zylindrische Drehwerkzeughalter» Dokumentation für weitere Informationen. Voir la documentation «Porte-outils de tournage cylindriques» pour plus d'informations.</p>	
001-7	Screw for tool holders SDJCR...07 and SVJCR...11 Schraube für Werkzeughalter SDJCR...07 und SVJCR...11 Vis pour porte-outils SDJCR...07 et SVJCR...11	Article nr. Artikel Nr. N° Article
	M2,5 x 7,5 T08	001-7
100-2	Screw for tool holders SCLCR...09 and SDJCR...11 Schraube für Werkzeughalter SCLCR...09 und SDJCR...11 Vis pour porte-outils SCLCR...09 et SDJCR...11	Article nr. Artikel Nr. N° Article
	M3,5 x 9,0 T15	100-2
001-1	Key Torx 8 for screw 001-2 Schlüssel Torx 8 für Schraube 001-2 Clé Torx 8 pour vis 001-2	Article nr. Artikel Nr. N° Article
	Torx 8	001-1
100-1	Key Torx 15 for screw 100-2 Schlüssel Torx 15 für Schraube 100-2 Clé Torx 15 pour vis 100-2	Article nr. Artikel Nr. N° Article
	Torx 15	100-1

CCGT...FNAZ7		CCGT insert with «FNAZ7» chip-breaker CCGT Wendeplatte mit «FNAZ7» Spanbrecher Plaque CCGT avec brise-copeau «FNAZ7»	r [mm]	Article nr. Artikel Nr. N° Article	QM3
		80°	0,2	CCGT 060202M FNAZ7	✓
			0,4	CCGT 060204M FNAZ7	✓
			0,1	CCGT 09T301M FNAZ7	✓
			0,2	CCGT 09T302M FNAZ7	✓
DCGT...FNAZ7		DCGT insert with «FNAZ7» chip-breaker DCGT Wendeplatte mit «FNAZ7» Spanbrecher Plaque DCGT avec brise-copeau «FNAZ7»	r [mm]	Article nr. Artikel Nr. N° Article	QM3
		55°	0,03	DCGT 070200M FNAZ7	✓
			0,1	DCGT 070201M FNAZ7	✓
			0,2	DCGT 070202M FNAZ7	✓
			0,1	DCGT 11T301M FNAZ7	✓
			0,2	DCGT 11T302M FNAZ7	✓
			0,4	DCGT 11T304M FNAZ7	✓
			0,8	DCGT 11T308M FNAZ7	✓
VCGT...FNAZ7		VCGT insert with «FNAZ7» chip-breaker VCGT Wendeplatte mit «FNAZ7» Spanbrecher Plaque VCGT avec brise-copeau «FNAZ7»	r [mm]	Article nr. Artikel Nr. N° Article	QM3
		35°	0,1	VCGT 110301M FNAZ7	✓
			0,2	VCGT 110302M FNAZ7	✓
			0,4	VCGT 110304M FNAZ7	✓
CCGT...MRS		CCGT insert with «MRS» chip-breaker CCGT Wendeplatte mit «MRS» Spanbrecher Plaque CCGT avec brise-copeau «MRS»	r [mm]	Article nr. Artikel Nr. N° Article	QM3
		80°	0,1	CCGT 09T301 MRS	✓
			0,2	CCGT 09T302 MRS	✓
DCGT...MRS		DCGT insert with «MRS» chip-breaker DCGT Wendeplatte mit «MRS» Spanbrecher Plaque DCGT avec brise-copeau «MRS»	r [mm]	Article nr. Artikel Nr. N° Article	QM3
		55°	0,1	DCGT 070201 MRS	✓
			0,2	DCGT 070202 MRS	✓
			0,1	DCGT 11T301 MRS	✓
			0,2	DCGT 11T302 MRS	✓
			0,4	DCGT 11T304 MRS	✓

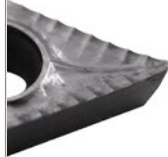
DCGT...BO	DCGT insert with «BO» chip-breaker DCGT Wendeplatte mit «BO» Spanbrecher Plaque DCGT avec brise-copeau «BO»	r [mm]	Article nr. Artikel Nr. N° Article	QM2
 		0,08	DCGT 0702008 BO	✓
		0,15	DCGT 0702015 BO	✓
		0,15	DCGT 11T3015 BO	✓
		0,35	DCGT 11T3035 BO	✓
VCGT...BO	VCGT insert with «BO» chip-breaker VCGT Wendeplatte mit «BO» Spanbrecher Plaque VCGT avec brise-copeau «BO»	r [mm]	Article nr. Artikel Nr. N° Article	QM2
 		0,08	VCGT 1103008 BO	✓
		0,15	VCGT 1103015 BO	✓
DCGT...FN-EF	DCGT insert with «FN-EF» chip-breaker DCGT Wendeplatte mit «FN-EF» Spanbrecher Plaque DCGT avec brise-copeau «FN-EF»	r [mm]	Article nr. Artikel Nr. N° Article	BI90
 		0,05	DCGT 11T3005 FN-EF	✓
		0,1	DCGT 11T301 FN-EF	✓
		0,2	DCGT 11T302 FN-EF	✓
VCGT...FN-EF	VCGT insert with «FN-EF» chip-breaker VCGT Wendeplatte mit «FN-EF» Spanbrecher Plaque VCGT avec brise-copeau «FN-EF»	r [mm]	Article nr. Artikel Nr. N° Article	BI90
 		0,05	VCGT 1103005 FN-EF	✓
		0,1	VCGT 110301 FN-EF	✓
		0,2	VCGT 110302 FN-EF	✓
VCGT...EN-EF	VCGT insert with «EN-EF» chip-breaker VCGT Wendeplatte mit «EN-EF» Spanbrecher Plaque VCGT avec brise-copeau «EN-EF»	r [mm]	Article nr. Artikel Nr. N° Article	BI90
 		0,1	VCGT 110301 EN-EF	✓
		0,2	VCGT 110302 EN-EF	✓
			Treated cutting edges. Bearbeitete Schneidkanten. Arêtes de coupe traitées.	

DCGT...BAL	DCGT insert with «BAL» chip-breaker DCGT Wendeplatte mit «BAL» Spanbrecher Plaquette DCGT avec brise-copeau «BAL»	r [mm]	Article nr. Artikel Nr. N° Article	BI30
 	<h2>55°</h2>	0,2	DCGT 070202BAL	✓
		0,4	DCGT 070204BAL	✓
		0,2	DCGT 11T302BAL	✓
		0,4	DCGT 11T304BAL	✓

VCGT...BAL	VCGT insert with «BAL» chip-breaker VCGT Wendeplatte mit «BAL» Spanbrecher Plaquette VCGT avec brise-copeau «BAL»	r [mm]	Article nr. Artikel Nr. N° Article	BI30
 	<h2>35°</h2>	0,2	VCGT 110302BAL	✓
		0,4	VCGT 110304BAL	✓

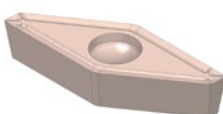
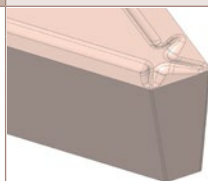
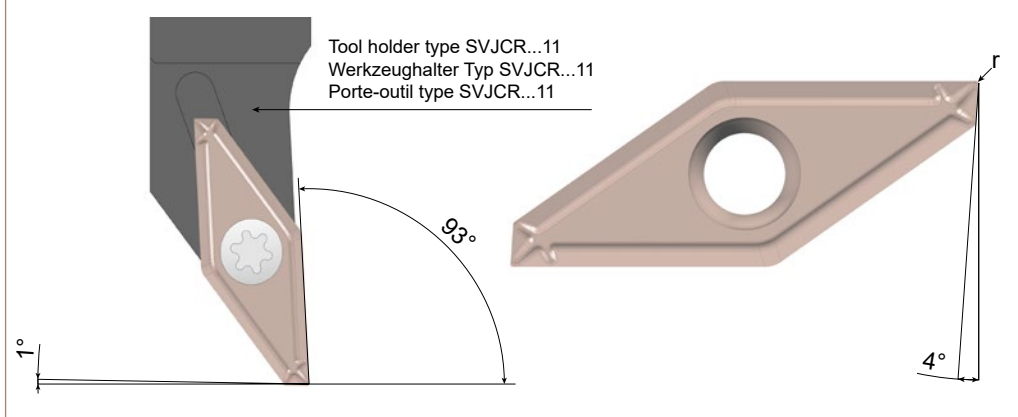
VCGT...FR	VCGT insert VCGT Wendeplatte Plaquette VCGT	r [mm]	Article nr. Artikel Nr. N° Article	BI120
 	<h2>35°</h2>	0,03	VCGT 1103003 FR	✓
		0,08	VCGT 1103008 FR	✓
 <p>Tool holder type SVJCR...11 Werkzeughalter Typ SVJCR...11 Porte-outil type SVJCR...11</p> <p>New Neu Nouveau</p>				



Represented by Vertreten durch Représenté par

