

# ISO line

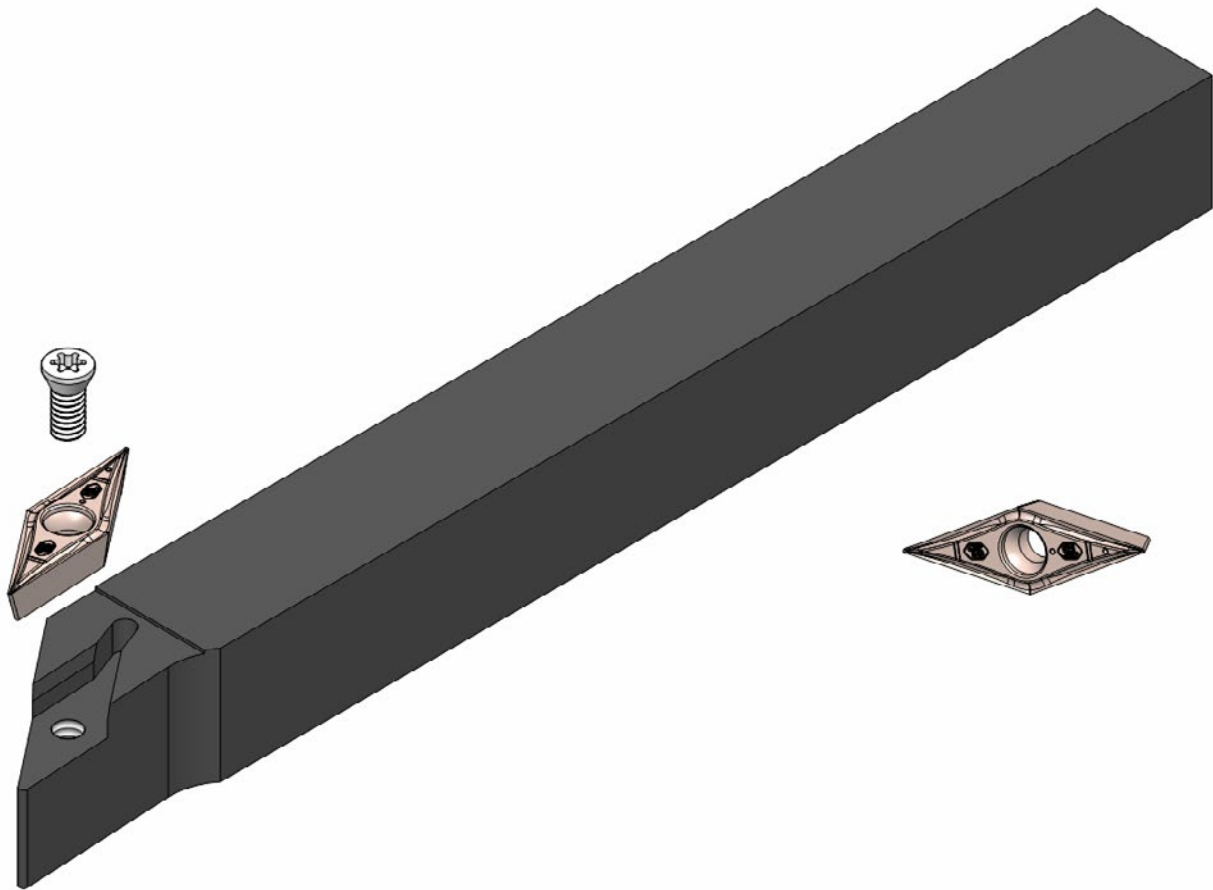

**Coating of inserts**  
**Beschichtung der Wendepplatten**  
**Revêtement des plaquettes**



✓ = Available  
 ✓ = Verfügbar  
 ✓ = Disponible



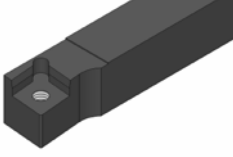
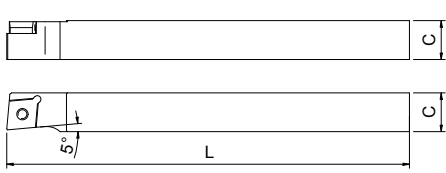
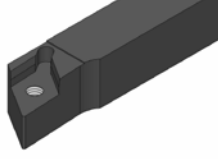
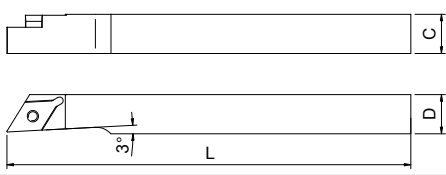
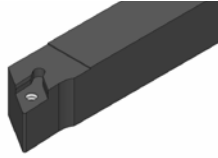
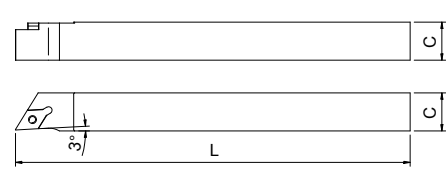
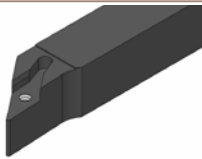
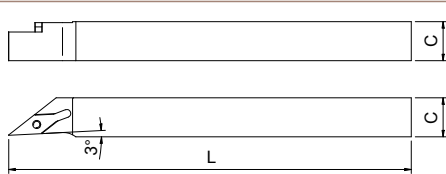
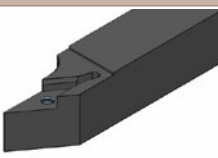
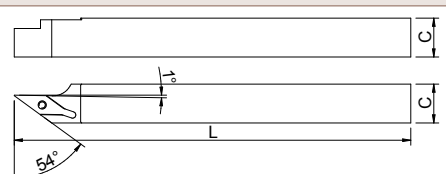
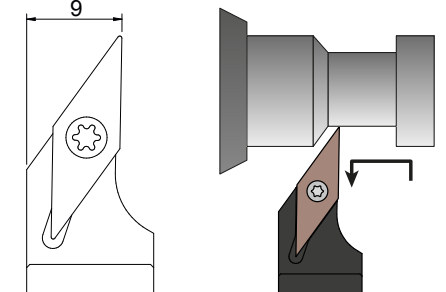
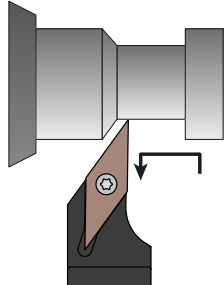



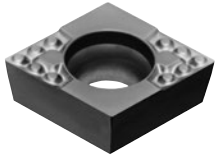
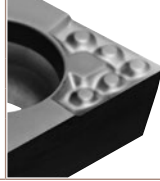
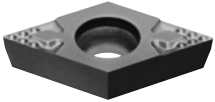
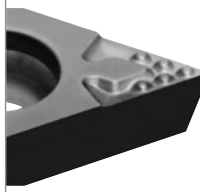

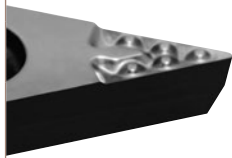
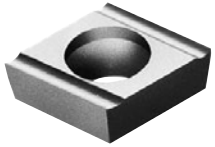
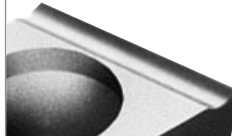
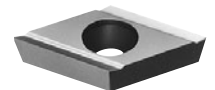
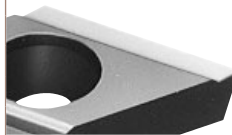
Designation Bezeichnung Désignation	Description Beschreibung Description
<b>QM2</b> <b>QM3</b>	<b>TiAlN-based</b> <ul style="list-style-type: none"> <li>• Universal grade for steel, stainless steel and heat-resistant alloys.</li> </ul> <b>TiAlN-Basis</b> <ul style="list-style-type: none"> <li>• Universalsorte für Stahl, Edelstahl und hitzebeständige Legierungen.</li> </ul> <b>Base TiAlN</b> <ul style="list-style-type: none"> <li>• Qualité universelle pour l'acier, l'acier inoxydable et les alliages résistants à la chaleur.</li> </ul>
<b>BI30</b>	<b>AlTiN-based + Micro finish</b> <ul style="list-style-type: none"> <li>• Very sharp cutting edges.</li> <li>• Very smooth surface finish, ideal for non-ferrous materials.</li> </ul> <b>AlTiN-Basis + «Micro finish»</b> <ul style="list-style-type: none"> <li>• Sehr scharfe Schneidkanten.</li> <li>• Sehr glatte Oberfläche, ideal für Nichteisenwerkstoffe.</li> </ul> <b>Base AlTiN + «Micro finish»</b> <ul style="list-style-type: none"> <li>• Arêtes de coupe très vives.</li> <li>• Bon glissement du copeau, idéal pour les matériaux non ferreux.</li> </ul>
<b>BI90</b>	<b>AlTiN-based</b> <ul style="list-style-type: none"> <li>• Universal coating.</li> <li>• Good oxidation resistance.</li> <li>• High heat resistance.</li> <li>• Suitable for steel and stainless steel.</li> </ul> <b>AlTiN-Basis</b> <ul style="list-style-type: none"> <li>• Universalbeschichtung.</li> <li>• Gute Oxidationsbeständigkeit.</li> <li>• Hohe Hitzebeständigkeit.</li> <li>• Ideal für Stahl und Edelstahl.</li> </ul> <b>Base AlTiN</b> <ul style="list-style-type: none"> <li>• Revêtement universel.</li> <li>• Bonne résistance à l'oxydation.</li> <li>• Haute résistance à la chaleur..</li> <li>• Adapté à l'acier et à l'acier inox.</li> </ul>

Designation Bezeichnung Désignation	Description Beschreibung Description
<b>BI120</b>	<p><b>AlCrN-based</b></p> <ul style="list-style-type: none"> <li>• Optimal for cutting edges subject to heavy wear.</li> <li>• Very high heat resistance.</li> <li>• High coating adhesion.</li> </ul> <p><b>AlCrN-Basis</b></p> <ul style="list-style-type: none"> <li>• Optimal für stark beanspruchte Schneidkanten.</li> <li>• Sehr hohe Hitzebeständigkeit.</li> <li>• Hohe Schichthaftung.</li> </ul> <p><b>Base AlCrN</b></p> <ul style="list-style-type: none"> <li>• Optimal pour les arêtes de coupe soumises à une forte usure.</li> <li>• Très haute résistance à la chaleur.</li> <li>• Haute adhérence du revêtement.</li> </ul>

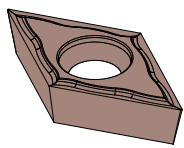
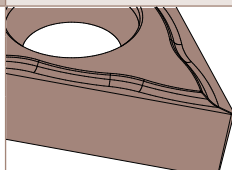
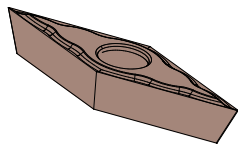

<b>SCLCR...09</b>	<b>ISO 95° right tool holder</b> <b>ISO 95° rechter Werkzeughalter</b> <b>Porte-outil ISO 95° à droite</b>	Section C Querschnitt C Section C	Length L Länge L Longueur L	Article nr. Artikel Nr. N° Article
		12 x 12 16 x 16	125 100	SCLCR 1212 K09 SCLCR 1616 H09
		For inserts Für Wendepplatten Pour plaquettes		
		CC..09T3..		
<b>SDJCR...11</b>	<b>ISO 93° right tool holder</b> <b>ISO 93° rechter Werkzeughalter</b> <b>Porte-outil ISO 93° à droite</b>	Section C x D Querschnitt C x D Section C x D	Length L Länge L Longueur L	Article nr. Artikel Nr. N° Article
		8 x 12 10 x 12 12 x 12 16 x 16	125 125 125 100	SDJCR 0812 K11 SDJCR 1012 K11 SDJCR 1212 K11 SDJCR 1616 H11
		For inserts Für Wendepplatten Pour plaquettes		
		DC..11T3..		
<b>SDJCR...07</b>	<b>ISO 93° right tool holder</b> <b>ISO 93° rechter Werkzeughalter</b> <b>Porte-outil ISO 93° à droite</b>	Section C Querschnitt C Section C	Length L Länge L Longueur L	Article nr. Artikel Nr. N° Article
		8 x 8 10 x 10 12 x 12 16 x 16	125 125 125 100	SDJCR 0808 K07 SDJCR 1010 K07 SDJCR 1212 K07 SDJCR 1616 H07
		For inserts Für Wendepplatten Pour plaquettes		
		DC..0702..		
<b>SVJCR...11</b>	<b>ISO 93° right tool holder</b> <b>ISO 93° rechter Werkzeughalter</b> <b>Porte-outil ISO 93° à droite</b>	Section C Querschnitt C Section C	Length L Länge L Longueur L	Article nr. Artikel Nr. N° Article
		8 x 8 10 x 10 12 x 12 16 x 16	125 125 125 100	SVJCR 0808 K11 SVJCR 1010 K11 SVJCR 1212 K11 SVJCR 1616 H11
		For inserts Für Wendepplatten Pour plaquettes		
		VC..1103..		
<b>SVCR-X...11</b>	<b>ISO 91° right tool holder</b> <b>ISO 91° rechter Werkzeughalter</b> <b>Porte-outil ISO 91° à droite</b>	Section C Querschnitt C Section C	Length L Länge L Longueur L	Article nr. Artikel Nr. N° Article
		12 x 12 16 x 16	125 125	SVCR-1212X-K11 SVCR-1616X-K11
		For inserts Für Wendepplatten Pour plaquettes		
		VC..1103..		
	 <p>           Tool holder used for back turning            Werkzeughalter zum Drehen hinter dem Bund            Porte-outil utilisé pour le tournage arrière         </p>			

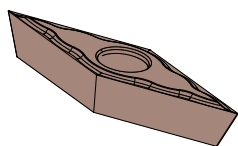
<b>Tool holders with internal coolant</b> <b>Werkzeughalter mit Innenkühlung</b> <b>Porte-outils avec arrosage intégré</b>		
	<p>See the «Tool holders with internal coolan» documentation for further information.          Siehe die «Werkzeughalter mit Innenkühlung» Dokumentation für weitere Informationen.          Voir la documentation «Porte-outils avec arrosage intégré» pour plus d'informations.</p>	
<b>Turning tool holders for counter-operation</b> <b>Drehwerkzeughalter für Rückseitenbearbeitung</b> <b>Porte-outils de tournage pour contre-opération</b>		
	<p>See the «Cylindrical turning tool holders» documentation for further information.          Siehe die «Zylindrische Drehwerkzeughalter» Dokumentation für weitere Informationen.          Voir la documentation «Porte-outils de tournage cylindriques» pour plus d'informations.</p>	
<b>001-7</b>	<b>Screw for tool holders SDJCR...07 and SVJCR...11</b> <b>Schraube für Werkzeughalter SDJCR...07 und SVJCR...11</b> <b>Vis pour porte-outils SDJCR...07 et SVJCR...11</b>	Article nr. Artikel Nr. N° Article
	M2,5 x 7,5 T08	001-7
<b>100-2</b>	<b>Screw for tool holders SCLCR...09 and SDJCR...11</b> <b>Schraube für Werkzeughalter SCLCR...09 und SDJCR...11</b> <b>Vis pour porte-outils SCLCR...09 et SDJCR...11</b>	Article nr. Artikel Nr. N° Article
	M3,5 x 9,0 T15	100-2
<b>001-1</b>	<b>Key Torx 8 for screw 001-2</b> <b>Schlüssel Torx 8 für Schraube 001-2</b> <b>Clé Torx 8 pour vis 001-2</b>	Article nr. Artikel Nr. N° Article
	Torx 8	001-1
<b>100-1</b>	<b>Key Torx 15 for screw 100-2</b> <b>Schlüssel Torx 15 für Schraube 100-2</b> <b>Clé Torx 15 pour vis 100-2</b>	Article nr. Artikel Nr. N° Article
	Torx 15	100-1

CCGT...FNAZ7	CCGT insert with «FNAZ7» chip-breaker CCGT Wendeplatte mit «FNAZ7» Spanbrecher Plaque CCGT avec brise-copeau «FNAZ7»	r [mm]	Article nr. Artikel Nr. N° Article	QM3	
		80°	0,2	CCGT 060202M FNAZ7	✓
			0,4	CCGT 060204M FNAZ7	✓
			0,1	CCGT 09T301M FNAZ7	✓
			0,2	CCGT 09T302M FNAZ7	✓
DCGT...FNAZ7	DCGT insert with «FNAZ7» chip-breaker DCGT Wendeplatte mit «FNAZ7» Spanbrecher Plaque DCGT avec brise-copeau «FNAZ7»	r [mm]	Article nr. Artikel Nr. N° Article	QM3	
		55°	0,03	DCGT 070200M FNAZ7	✓
			0,1	DCGT 070201M FNAZ7	✓
			0,2	DCGT 070202M FNAZ7	✓
			0,1	DCGT 11T301M FNAZ7	✓
			0,2	DCGT 11T302M FNAZ7	✓
			0,4	DCGT 11T304M FNAZ7	✓
			0,8	DCGT 11T308M FNAZ7	✓
VCGT...FNAZ7	VCGT insert with «FNAZ7» chip-breaker VCGT Wendeplatte mit «FNAZ7» Spanbrecher Plaque VCGT avec brise-copeau «FNAZ7»	r [mm]	Article nr. Artikel Nr. N° Article	QM3	
		35°	0,1	VCGT 110301M FNAZ7	✓
			0,2	VCGT 110302M FNAZ7	✓
			0,4	VCGT 110304M FNAZ7	✓
CCGT...MRS	CCGT insert with «MRS» chip-breaker CCGT Wendeplatte mit «MRS» Spanbrecher Plaque CCGT avec brise-copeau «MRS»	r [mm]	Article nr. Artikel Nr. N° Article	QM3	
		80°	0,1	CCGT 09T301 MRS	✓
			0,2	CCGT 09T302 MRS	✓
DCGT...MRS	DCGT insert with «MRS» chip-breaker DCGT Wendeplatte mit «MRS» Spanbrecher Plaque DCGT avec brise-copeau «MRS»	r [mm]	Article nr. Artikel Nr. N° Article	QM3	
		55°	0,1	DCGT 070201 MRS	✓
			0,2	DCGT 070202 MRS	✓
			0,1	DCGT 11T301 MRS	✓
			0,2	DCGT 11T302 MRS	✓
			0,4	DCGT 11T304 MRS	✓

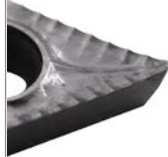
DCGT...BO	DCGT insert with «BO» chip-breaker DCGT Wendeplatte mit «BO» Spanbrecher Plaque DCGT avec brise-copeau «BO»	r [mm]	Article nr. Artikel Nr. N° Article	QM2
 		0,08	DCGT 0702008 BO	✓
		0,15	DCGT 0702015 BO	✓
		0,15	DCGT 11T3015 BO	✓
		0,35	DCGT 11T3035 BO	✓
VCGT...BO	VCGT insert with «BO» chip-breaker VCGT Wendeplatte mit «BO» Spanbrecher Plaque VCGT avec brise-copeau «BO»	r [mm]	Article nr. Artikel Nr. N° Article	QM2
 		0,08	VCGT 1103008 BO	✓
		0,15	VCGT 1103015 BO	✓
DCGT...FN-EF	DCGT insert with «FN-EF» chip-breaker DCGT Wendeplatte mit «FN-EF» Spanbrecher Plaque DCGT avec brise-copeau «FN-EF»	r [mm]	Article nr. Artikel Nr. N° Article	BI90
 		0,05	DCGT 11T3005 FN-EF	✓
		0,1	DCGT 11T301 FN-EF	✓
		0,2	DCGT 11T302 FN-EF	✓
VCGT...FN-EF	VCGT insert with «FN-EF» chip-breaker VCGT Wendeplatte mit «FN-EF» Spanbrecher Plaque VCGT avec brise-copeau «FN-EF»	r [mm]	Article nr. Artikel Nr. N° Article	BI90
 		0,05	VCGT 1103005 FN-EF	✓
		0,1	VCGT 110301 FN-EF	✓
		0,2	VCGT 110302 FN-EF	✓
VCGT...EN-EF	VCGT insert with «EN-EF» chip-breaker VCGT Wendeplatte mit «EN-EF» Spanbrecher Plaque VCGT avec brise-copeau «EN-EF»	r [mm]	Article nr. Artikel Nr. N° Article	BI90
 		0,1	VCGT 110301 EN-EF	✓
		0,2	VCGT 110302 EN-EF	✓
			Treated cutting edges. Bearbeitete Schneidkanten. Arêtes de coupe traitées.	

DCGT...BAL	DCGT insert with «BAL» chip-breaker DCGT Wendeplatte mit «BAL» Spanbrecher Plaquette DCGT avec brise-copeau «BAL»	r [mm]	Article nr. Artikel Nr. N° Article	BI30
 	<h2>55°</h2>	0,2	DCGT 070202BAL	✓
		0,4	DCGT 070204BAL	✓
		0,2	DCGT 11T302BAL	✓
		0,4	DCGT 11T304BAL	✓

VCGT...BAL	VCGT insert with «BAL» chip-breaker VCGT Wendeplatte mit «BAL» Spanbrecher Plaquette VCGT avec brise-copeau «BAL»	r [mm]	Article nr. Artikel Nr. N° Article	BI30
 	<h2>35°</h2>	0,2	VCGT 110302BAL	✓
		0,4	VCGT 110304BAL	✓

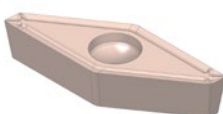
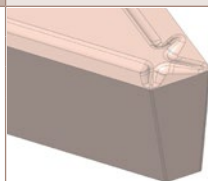
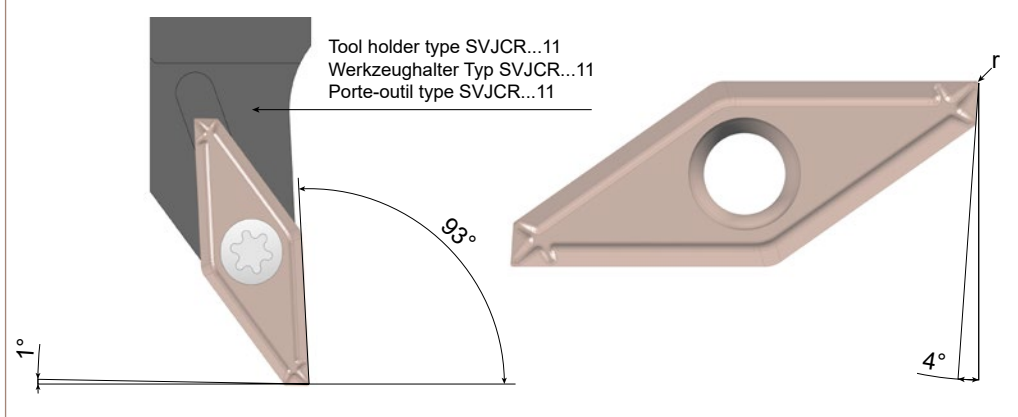
VCGT...FR	VCGT insert VCGT Wendeplatte Plaquette VCGT	r [mm]	Article nr. Artikel Nr. N° Article	BI120
 	<h2>35°</h2>	0,03	VCGT 1103003 FR	✓
		0,08	VCGT 1103008 FR	✓
<div style="background-color: yellow; padding: 5px; display: inline-block;"> <b>New New Nouveau</b> </div>				
 <p>       Tool holder type SVJCR...11        Werkzeughalter Typ SVJCR...11        Porte-outil type SVJCR...11     </p> <p>       1°        93°        4°     </p>				











Represented by    Vertreten durch    Représenté par

