







# Hydraulic connectors Hydraulikanschlüsse Raccords hydrauliques



Standard hydraulic connectors  
Standard-Hydraulikanschlüsse  
Raccords hydrauliques standards

High pressure up to  
Hochdruck bis  
Haute pression jusqu'à

**150 bar**

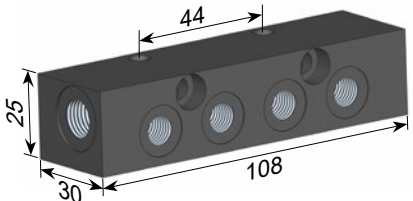
|  | Description<br>Bezeichnung<br>Description   | Article nr.<br>Artikel Nr.<br>N° Article |
|--|---|--|
|   | High pressure tube 100 mm, G1/8"<br>Hochdruckrohr 100 mm, G1/8"<br>Tuyau haute pression 100 mm, G1/8"   | 01.04.4295                               |
|   | High pressure tube 180 mm, G1/8"<br>Hochdruckrohr 180 mm, G1/8"<br>Tuyau haute pression 180 mm, G1/8"   | 01.04.4000                               |
|   | High pressure tube 300 mm, G1/8"<br>Hochdruckrohr 300 mm, G1/8"<br>Tuyau haute pression 300 mm, G1/8"   | 01.04.3870                               |
|    | High pressure tube 400 mm, G1/8"<br>Hochdruckrohr 400 mm, G1/8"<br>Tuyau haute pression 400 mm, G1/8"   | 01.04.4302                               |
|   | Straight connector G1/8"<br>Gerade Verbindung G1/8"<br>Raccord droit G1/8"  | 01.04.2292                               |
|   | Angled connector G1/8"<br>Winkelstecker G1/8<br>Raccord coudé G1/8"   | 01.04.3340                               |
|   | Straight connector M8x1<br>Gerade Verbindung M8x1<br>Raccord droit M8x1   | 01.04.3939                               |
|   | Angled connector M8x1<br>Winkelstecker M8x1<br>Raccord coudé M8x1   | 01.04.3340.1                             |
|  | Distributor with<br>1 input G1/4" and 4 outputs G1/8"<br>Verteilerblock mit<br>1 Eingang G1/4" und 4 Ausgänge G1/8"<br>Distributeur avec<br>1 entrée G1/4" et 4 sorties G1/8" | 02.01.0041                               |

"RH" type hydraulic connectors  
Hydraulikanschlüsse Typ "RH"  
Raccords hydrauliques de type "RH"

High pressure up to  
Hochdruck bis  
Haute pression jusqu'à

**250 bar**

Hose with metal weave: highly abrasion resistant  
Schlauch mit Metall-Ummantelung: sehr abriebfest  
Tuyau avec tissage métallique: très résistant à l'abrasion



Quick change coupling: no key required  
Schnellwechsellkupplung: kein Schraubenschlüssel erforderlich  
Raccord à changement rapide: pas besoin de clé

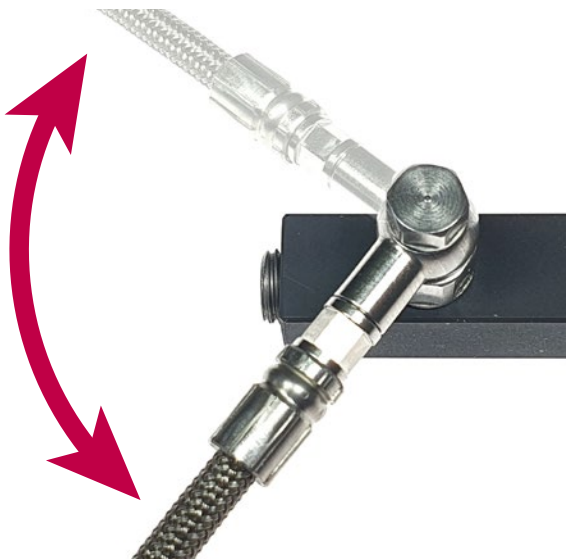
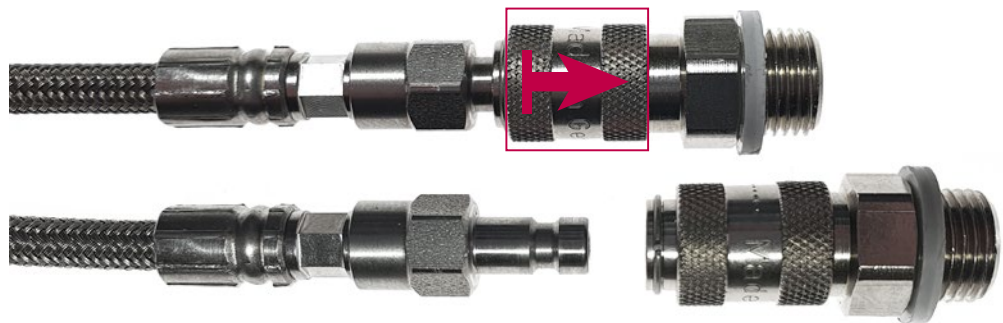

Swivel joint: easy connection of tools  
Drehgelenk: einfacher Anschluss von Werkzeugen  
Raccord orientable: connection facilitée des outils

|   | Description<br>Bezeichnung<br>Description   | Article nr.<br>Artikel Nr.<br>N° Article |
|---|---|--|
|    | Banjo screw, external threading M5x0,5<br>Hohlschraube, Aussengewinde M5x0,5<br>Vis banjo, filet extérieur M5x0,5   | RH22-40050530                            |
|    | Banjo screw, external threading M5<br>Hohlschraube, Aussengewinde M5<br>Vis banjo, filet extérieur M5   | RH22-40050830                            |
|    | «Ringfitting», internal threading M5x0,5<br>«Ringfitting», Innengewinde M5x0,5<br>«Ringfitting», filetage intérieur M5x0,5  | RH24-3250030                             |
|   | 90° angle connector, internal threading M5x0,5,<br>external threading M5<br>90° Winkelanschluss, Innengewinde M5x0,5,<br>Aussengewinde M5<br>Raccord coudé à 90°, filetage intérieur M5x0,5,<br>filetage extérieur M5                 | RH23-3908530                             |
|  | 90° angle connector, internal threading M5x0,5,<br>external threading M5x0,5<br>90° Winkelanschluss, Innengewinde M5x0,5,<br>Aussengewinde M5x0,5<br>Raccord coudé à 90°, filetage intérieur M5x0,5,<br>filetage extérieur M5x0,5     | RH23-3908830                             |
|  | «Stahlflex» high pressure hose, length 80 mm,<br>external threading M5x0,5<br>«Stahlflex» Hochdruckschlauch, Länge 80 mm,<br>Aussengewinde M5x0,5<br>Tube haute pression «Stahlflex», longueur 80<br>mm, filetage extérieur M5x0,5    | RH28-3008030                             |
|  | «Stahlflex» high pressure hose, length 100 mm,<br>external threading M5x0,5<br>«Stahlflex» Hochdruckschlauch, Länge 100 mm,<br>Aussengewinde M5x0,5<br>Tube haute pression «Stahlflex», longueur<br>100 mm, filetage extérieur M5x0,5 | RH28-3010030                             |
|  | «Stahlflex» high pressure hose, length 180 mm,<br>external threading M5x0,5<br>«Stahlflex» Hochdruckschlauch, Länge 180 mm,<br>Aussengewinde M5x0,5<br>Tube haute pression «Stahlflex», longueur<br>180 mm, filetage extérieur M5x0,5 | RH28-3018030                             |

|  | Description<br>Bezeichnung<br>Description  | Article nr.<br>Artikel Nr.<br>N° Article |
|--|--|--|
|   | <p>Coupling plug, internal threading M5x0,5<br/>Kupplung-Stecker, Innengewinde M5x0,5<br/>Fiche de couplage, filetage intérieur M5x0,5</p>   | RH804012330                              |
|   | <p>Quick coupling, external threading G1/8".<br/>△ High pressure only up to 150 bar<br/>Schnellverschlusskupplung,<br/>Aussengewinde G1/8"<br/>△ Hochdruck nur bis 150 bar<br/>Raccord rapide, filet extérieur G1/8"<br/>△ Haute pression uniquement jusqu'à 150 bar</p> | RH816180100                              |
|    | <p>Adaptor, external threading M8x1,<br/>internal threading M5x0,5<br/>Adapter, Aussengewinde M8x1,<br/>Innengewinde M5x0,5<br/>Adaptateur, filetage extérieur M8x1,<br/>filetage intérieur M5x0,5</p>   | RH54-358000030                           |
|  | <p>Adaptor, external threading G1/8",<br/>internal threading M8x1<br/>Adapter, Aussengewinde G1/8",<br/>Innengewinde M8x1<br/>Adaptateur, filetage extérieur G1/8",<br/>filetage intérieur M8x1</p>  | RH101980                                 |
|   | <p>Reduction for hydraulic connector from G1/4"<br/>to G1/8"<br/>Hydraulik Reduzierung von G1/4" auf G1/8"<br/>Réduction hydraulique de G1/4" à G1/8"</p>  | RED G1/4" - G1/8"                        |

Examples of possible set-ups  
Beispiele für mögliche Verbindungen  
Exemples de montages possibles

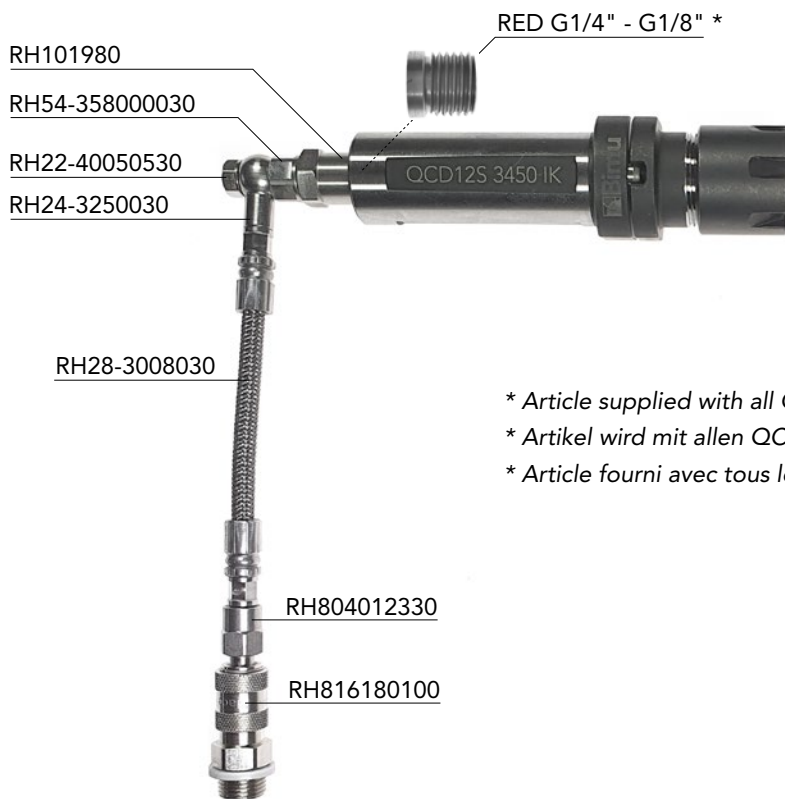
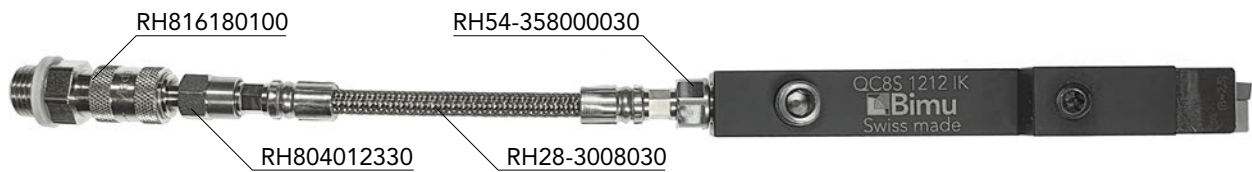

\* Article supplied with all QCD tool holders  
\* Artikel wird mit allen QCD-Werkzeughaltern geliefert  
\* Article fourni avec tous les porte-outils de type QCD

Examples of possible set-ups  
Beispiele für mögliche Verbindungen  
Exemples de montages possibles





Represented by    Vertreten durch    Représenté par

