

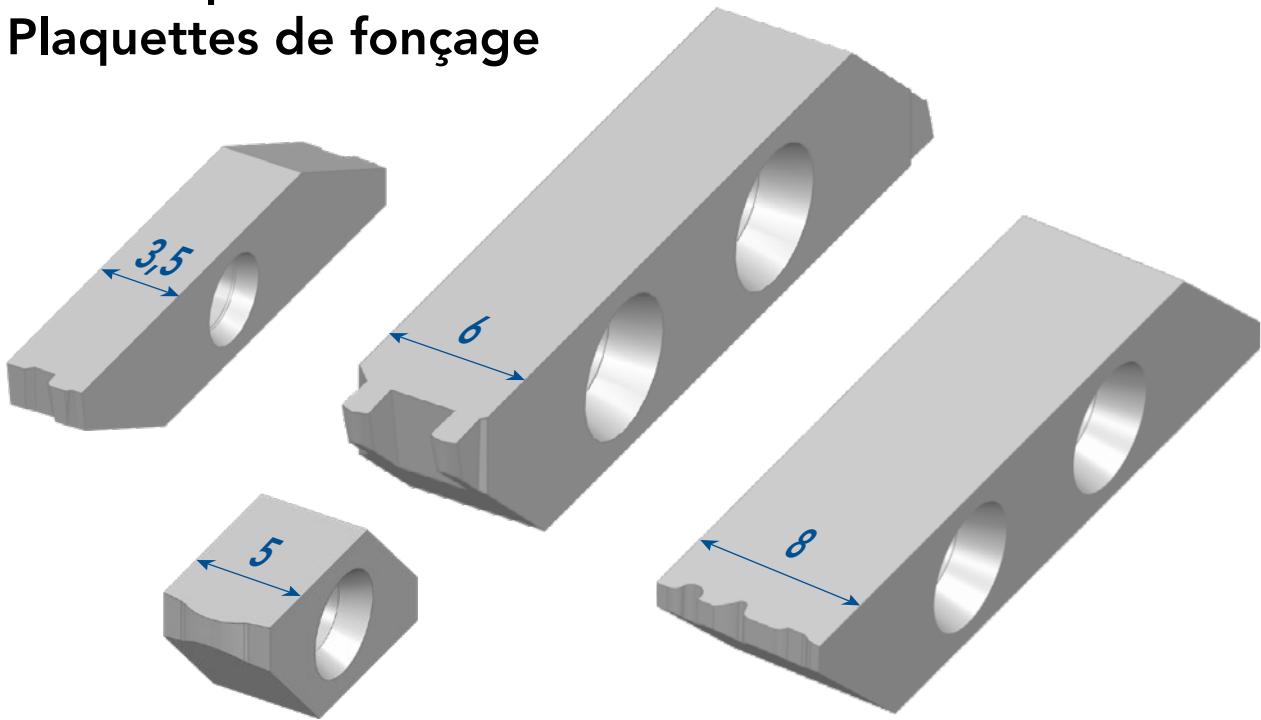

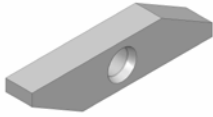

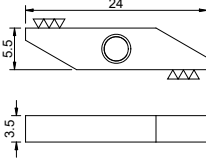





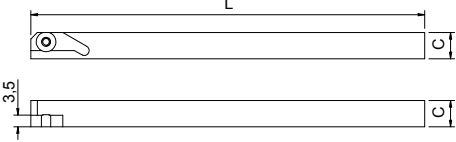
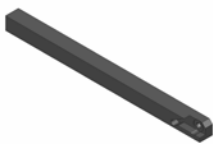
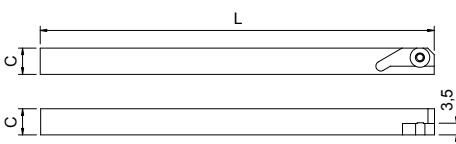

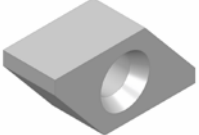
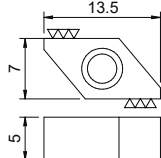

## Grooving inserts Einstechplatten Plaquettes de fonçage

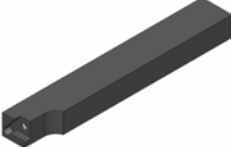
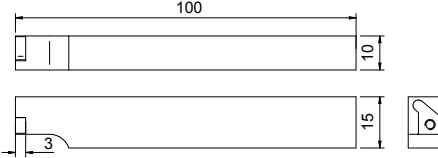
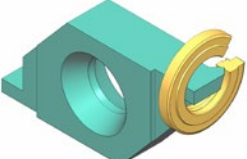



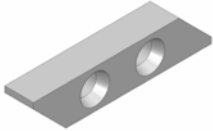
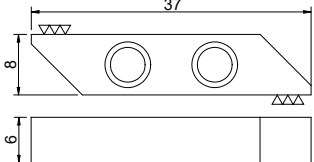

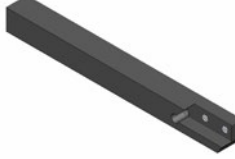
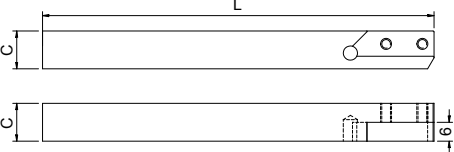

- Fully ground to your specification (examples of profiles illustrated).
- 4 different widths of blank inserts available.
- Double ended.
- Coated inserts.
  
- Realisierung nach kundenspezifischen Angaben.  
(Bilder : Realisierbare Profilbeispiele)
- 4 verschiedene Breiten der Wendepplattenrohlinge verfügbar.
- 2 Schneidkanten.
- Beschichtete Wendepplatte.
  
- Réalisation de profils personnalisés (ci-dessus : exemples de profils réalisables).
- 4 largeurs différentes d'ébauches disponibles.
- 2 arêtes de coupe.
- Plaquette revêtue.

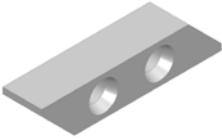
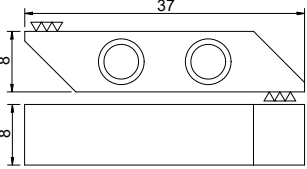
<b>040R/L3,5K18</b> <b>3,5 mm</b>	Blank insert 3,5 mm (left and right) Rohling 3,5 mm (links und rechts) Plaquette ébauche 3,5 mm (gauche et droite)	Article nr. Artikel Nr. N° Article		
		040R/L3,5K18		
<b>0xxR</b>	Right tool holder for 3,5 mm inserts Werkzeughalter rechts für 3,5 mm Wendeplatten Porte-outil à droite pour plaquettes 3,5 mm	Section C Querschnitt C Section C	Length L Länge L Longueur L	Article nr. Artikel Nr. N° Article
		7 x 7 8 x 8 10 x 10 12 x 12 16 x 16 20 x 20	120 120 120 120 100 100	007R 008R 010R 012R 016R 020R
<b>0xxL</b>	Left tool holder for 3,5 mm inserts Werkzeughalter links für 3,5 mm Wendeplatten Porte-outil à gauche pour plaquettes 3,5 mm	Section C Querschnitt C Section C	Length L Länge L Longueur L	Article nr. Artikel Nr. N° Article
		7 x 7 8 x 8 10 x 10 12 x 12 16 x 16 20 x 20	140 140 120 120 100 100	007L 008L 010L 012L 016L 020L
<b>001-2</b>	Screw for tool holders 0xxR and 0xxL Schraube für Werkzeughalter 0xxR und 0xxL Vis pour porte-outils 0xxR et 0xxL	Article nr. Artikel Nr. N° Article		
	M2,5 x 7,5	001-2		

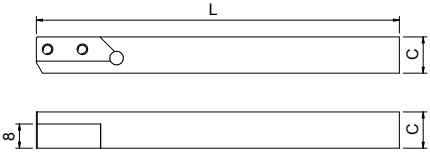
<b>340R5</b> <b>5 mm</b>	Blank insert 5 mm (left and right) Rohling 5 mm (links und rechts) Plaquette ébauche 5 mm (gauche et droite)	Article nr. Artikel Nr. N° Article		
		340R5		
<b>38xxR</b>	Right tool holder for 5 mm inserts Werkzeughalter rechts für 5 mm Wendeplatten Porte-outil à droite pour plaquettes 5 mm	Section C Querschnitt C Section C	Length L Länge L Longueur L	Article nr. Artikel Nr. N° Article
		10 x 10	100	3810R
		12 x 12	100	3812R
		16 x 16	100	3816R
<b>100-3</b>	Screw for tool holder 38xxR Schraube für Werkzeughalter 38xxR Vis pour porte-outil 38xxR	Article nr. Artikel Nr. N° Article		
	M3,0 x 10	100-3		
<b>3xx15RF</b>	Frontal tool holder for 3 mm inserts Frontalwerkzeughalter für 3 mm Wendeplatten Porte-outil frontal pour plaquettes 3 mm	Section C x D Querschnitt C x D Section C x D	Length L Länge L Longueur L	Article nr. Artikel Nr. N° Article
		10 x 15	100	31015RF
		12 x 15	100	31215RF
		<p>Please contact us for further information about 3 mm inserts.          Bitte kontaktieren Sie uns für weitere Informationen zu 3 mm Wendeplatten.          Veuillez nous contacter pour plus d'informations sur les plaquettes de 3 mm.</p>		
<b>001-3</b>	Screw for tool holder 3xx15RF Schraube für Werkzeughalter 3xx15RF Vis pour porte-outil 3xx15RF	Article nr. Artikel Nr. N° Article		
	M3,0 x 6,5	001-3		

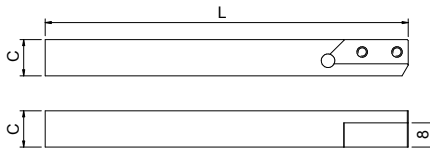
<b>715R/L-6</b> <b>6 mm</b>	Blank insert 6 mm (left and right) Rohling 6 mm (links und rechts) Plaquette ébauche 6 mm (gauche et droite)	Article nr. Artikel Nr. N° Article		
		715R/L-6		
<b>100BH3-1xxR-6</b>	Right tool holder for 6 mm inserts Werkzeughalter rechts für 6 mm Wendepplatten Porte-outil à droite pour plaquettes 6 mm	Section C Querschnitt C Section C	Length L Länge L Longueur L	Article nr. Artikel Nr. N° Article
		10 x 10	120	100BH3-110R-6
		12 x 12	120	100BH3-112R-6
		16 x 16	120	100BH3-116R-6
		20 x 20	120	100BH3-120R-6
<b>100BH3-1xxL-6</b>	Left tool holder for 6 mm inserts Werkzeughalter links für 6 mm Wendepplatten Porte-outil à gauche pour plaquettes 6 mm	Section C Querschnitt C Section C	Length L Länge L Longueur L	Article nr. Artikel Nr. N° Article
		12 x 12	120	100BH3-112L-6
		16 x 16	120	100BH3-116L-6
		20 x 20	120	100BH3-120L-6
<b>001-11</b>	Screw for tool holders 100BH3-1xxR-6 and 100BH3-1xxL-6 Schraube für Werkzeughalter 100BH3-1xxR-6 und 100BH3-1xxL-6 Vis pour porte-outils 100BH3-1xxR-6 et 100BH3-1xxL-6	Article nr. Artikel Nr. N° Article		
	M3,5 x 11,5	001-11		

<b>715R/L-8</b> <b>8 mm</b>	Blank insert 8 mm (left and right) Rohling 8 mm (links und rechts) Plaquette ébauche 8 mm (gauche et droite)	Article nr. Artikel Nr. N° Article		
		715R/L-8 <div style="float: right; background-color: yellow; padding: 5px; border: 1px solid black; text-align: center;"> <b>New New Nouveau</b> </div>		
<b>100BH3-1xxR-8</b>	Right tool holder for 8 mm inserts Werkzeughalter rechts für 8 mm Wendeplatten Porte-outil à droite pour plaquettes 8 mm	Section C Querschnitt C Section C	Length L Länge L Longueur L	Article nr. Artikel Nr. N° Article
		12 x 12	120	100BH3-112R-8
		16 x 16	120	100BH3-116R-8
<b>100BH3-1xxL-8</b>	Left tool holder for 8 mm inserts Werkzeughalter links für 8 mm Wendeplatten Porte-outil à gauche pour plaquettes 8 mm	Section C Querschnitt C Section C	Length L Länge L Longueur L	Article nr. Artikel Nr. N° Article
		12 x 12	120	100BH3-112L-8
		16 x 16	120	100BH3-116L-8
<b>001-11</b>	Screw for tool holders 100BH3-1xxR-8 and 100BH3-1xxL-8 Schraube für Werkzeughalter 100BH3-1xxR-8 und 100BH3-1xxL-8 Vis pour porte-outils 100BH3-1xxR-8 et 100BH3-1xxL-8			Article nr. Artikel Nr. N° Article
	M3,5 x 11,5			001-11







Represented by    Vertreten durch    Représenté par

