

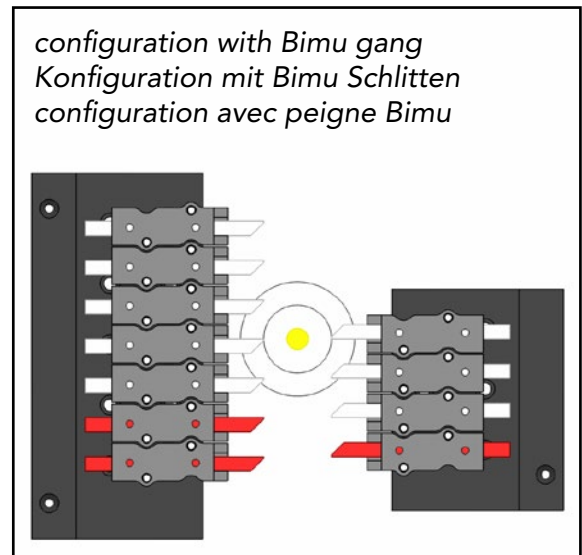

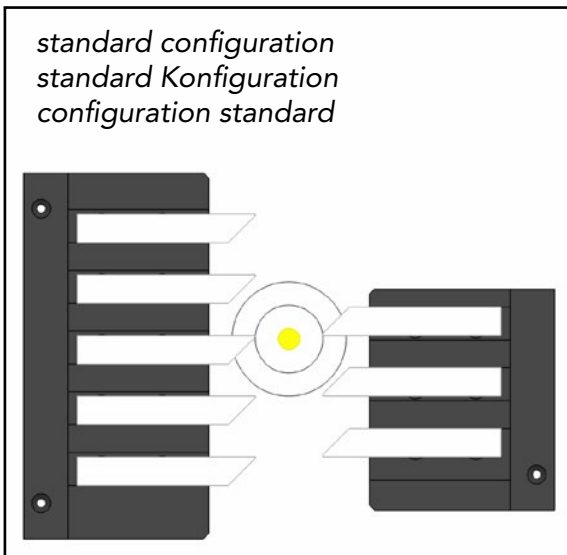

for | für | pour

**TORNOS Gamma 20**

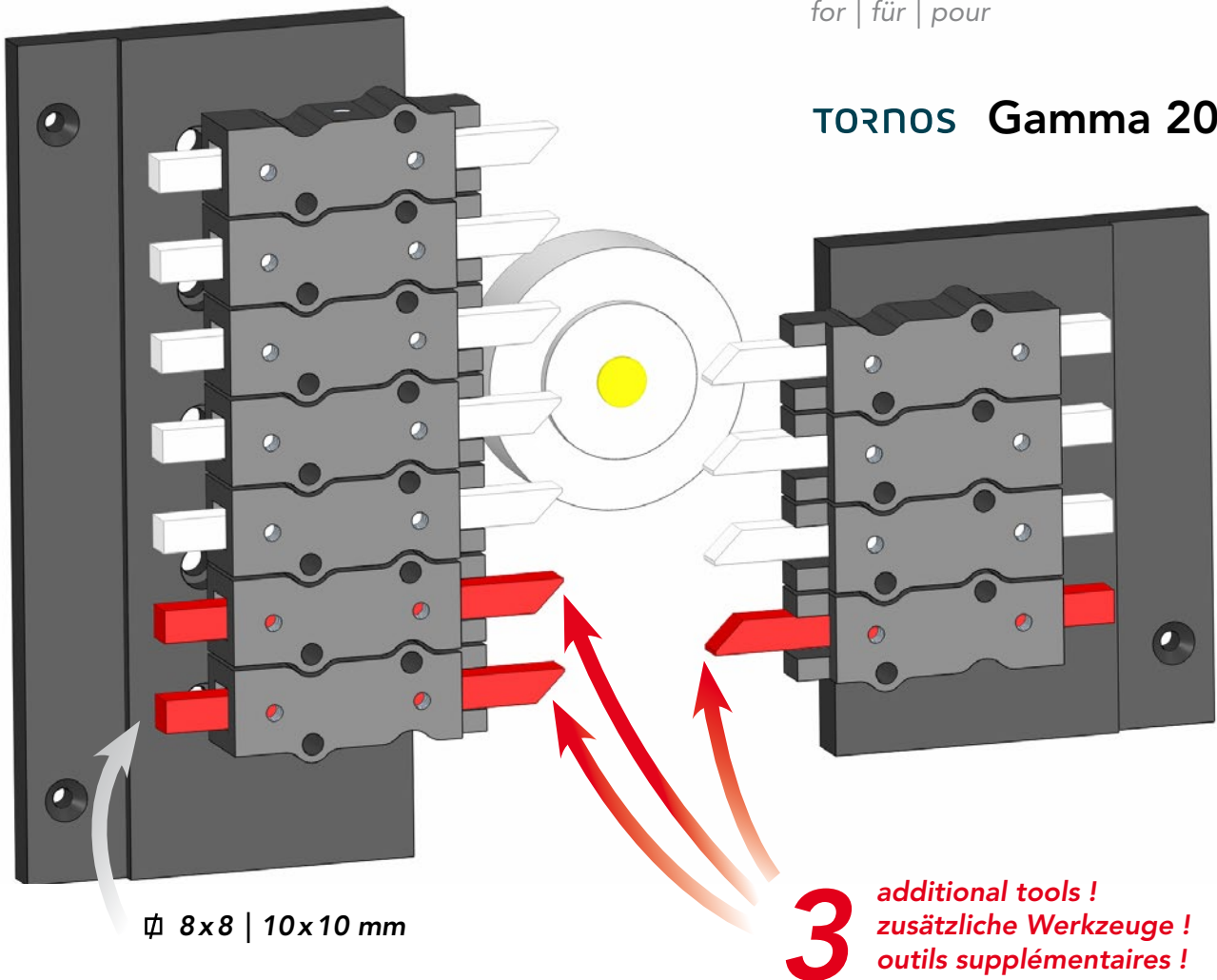
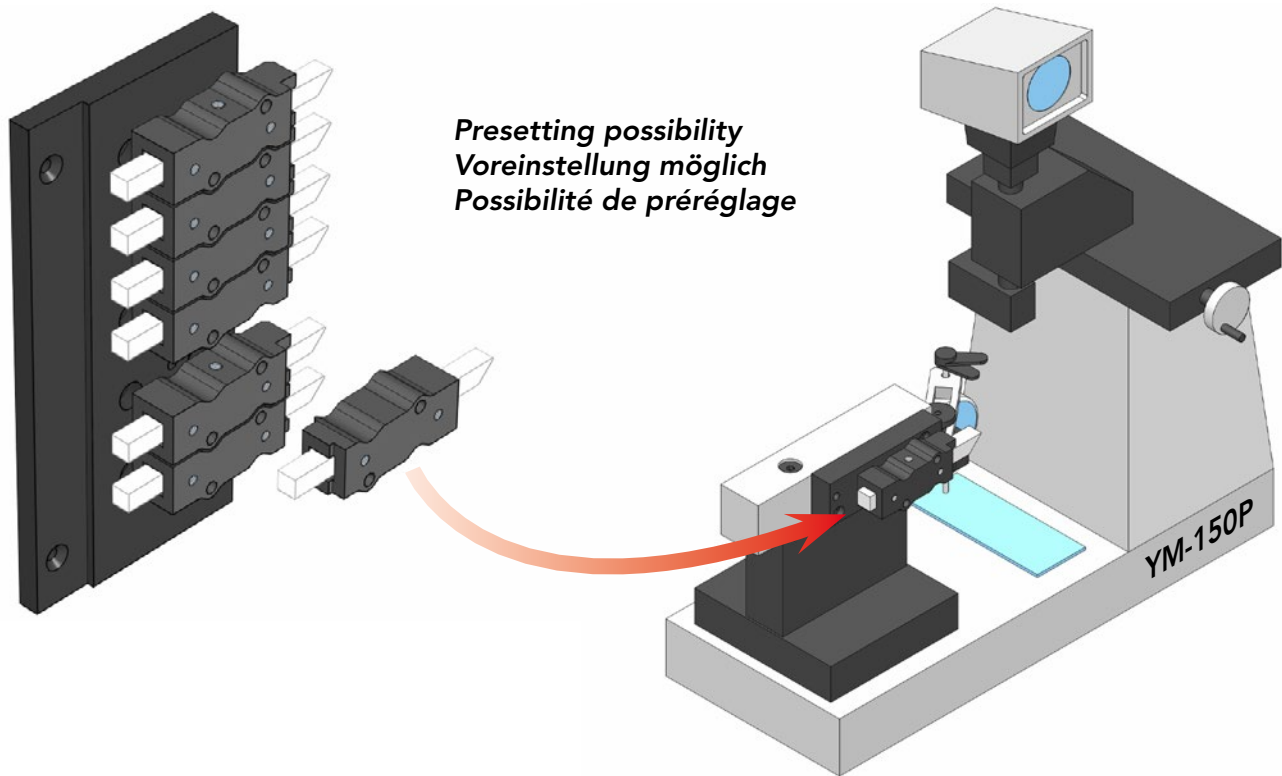
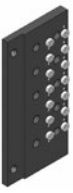

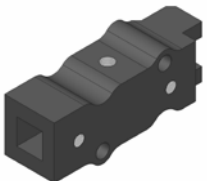

	Description Bezeichnung Description	Article nr. Artikel Nr. N° Article
	Baseplate 7 positions. Basisplatte 7 Positionen. Plaque de base 7 positions.	015.14.317
	Baseplate 4 positions. Basisplatte mit 4 Positionen. Plaque de base 4 positions.	015.14.314
	Tool holder for chisel of section 8x8 or 10x10 mm. Werkzeughalter für Drehstahl, Durchschnitt 8x8 oder 10x10 mm. Porte-outil pour burin de section 8x8 ou 10x10 mm.	015.14.210
	Presetting plate. Voreinstellplatte. Plaque de préréglage.	015.14.900