

Multiturn-Dec VPGT

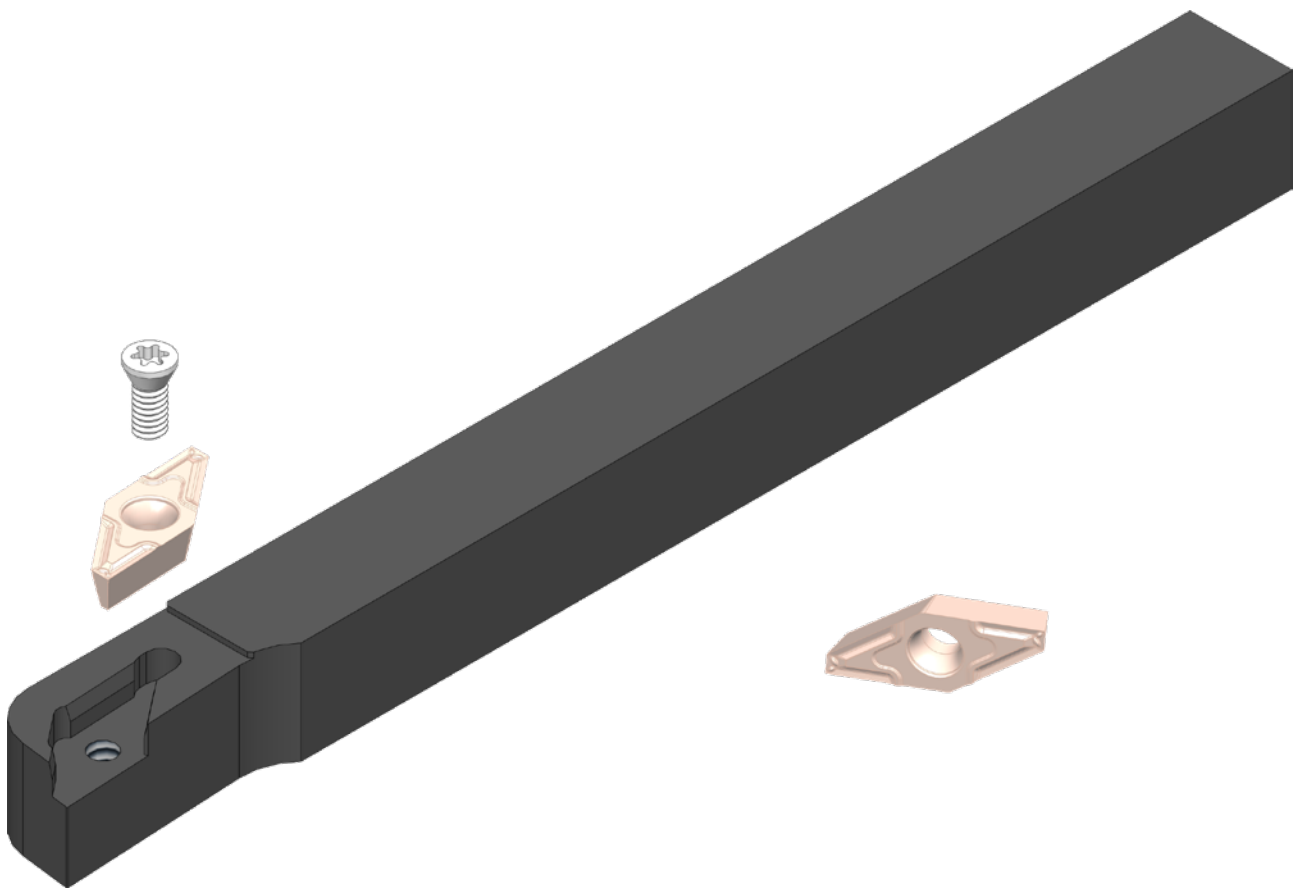

Presentation of Multiturn-Dec – VPGT
Vorstellung der Multiturn-Dec – VPGT
Présentation du Multiturn-Dec – VPGT

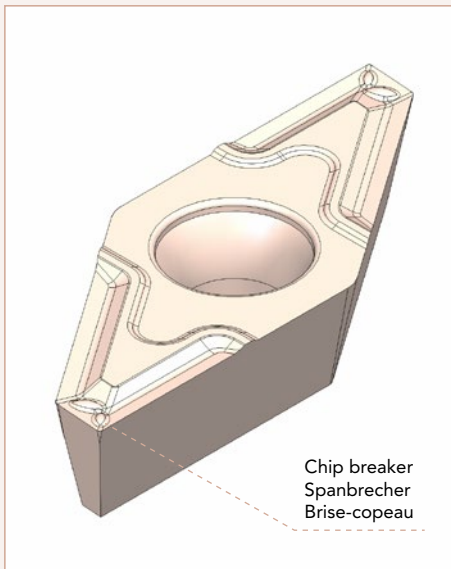
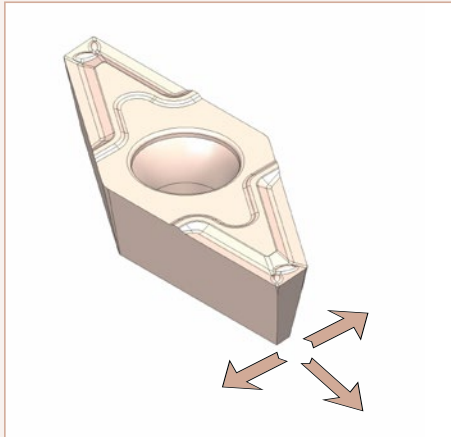

Advantages of Multiturn-Dec – VPGT

- General use for free turning, plungingturn and finishing.
- Ideal for deep removal of material.
- The insert has the same positive cutting angle in all turn direction.
- Cut control thanks to the chip breaker.

Vorteile der Multiturn-Dec – VPGT

- Generell anwendbar für das Längs-/Plandrehen und zum Schlichten.
- Ideal für große Materialabnahme.
- Die Wendeplatte hat in jeder Drehrichtung den gleichen positiven Spanwinkel.
- Gute Spankontrolle durch die Spanbruchgeometrie.

Avantages de la ligne Multiturn-Dec – VPGT

- Utilisation générale pour tournage, fonçage et finition.
- Idéal pour les grands enlèvements de matières.
- La plaquette a, dans toutes les directions, un angle de coupe positif tranchant.
- Maîtrise de la coupe grâce au brise-copeau.

Field of application of Multiturn-Dec – VPGT
Anwendungsbereiche von Multiturn-Dec – VPGT
Champ d'application du Multiturn-Dec – VPGT

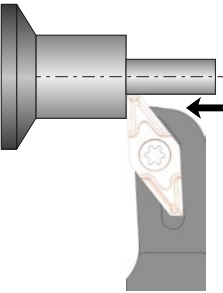
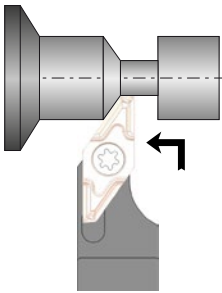
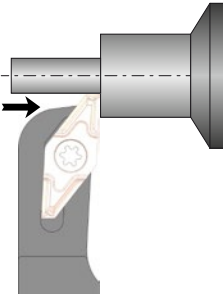
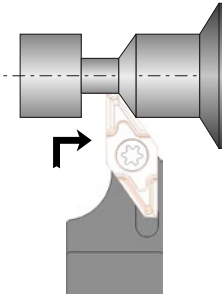
	Front turning Drehen vorne Tournage avant	Back turning Drehen hinten Tournage arrière
Right machining Rechte Bearbeitung Usinage à droite	 <p>Tool holders SVJP R... Inserts R</p> <p>Werkzeughalter SVJP R... Wendeplatten R</p> <p>Porte-outil SVJP R... Plaquettes R</p>	 <p>Tool holders SVXP R... Inserts L</p> <p>Werkzeughalter SVXP R... Wendeplatten L</p> <p>Porte-outil SVXP R... Plaquettes L</p>
Left machining Linke Bearbeitung Usinage à gauche	 <p>Tool holders SVJP L... Inserts L</p> <p>Werkzeughalter SVJP L... Wendeplatten L</p> <p>Porte-outil SVJP L... Plaquettes L</p>	 <p>Tool holders SVXP L... Inserts R</p> <p>Werkzeughalter SVXP L... Wendeplatten R</p> <p>Porte-outil SVXP L... Plaquettes R</p>

Cutting angles
Schneidwinkel
Angles de coupe

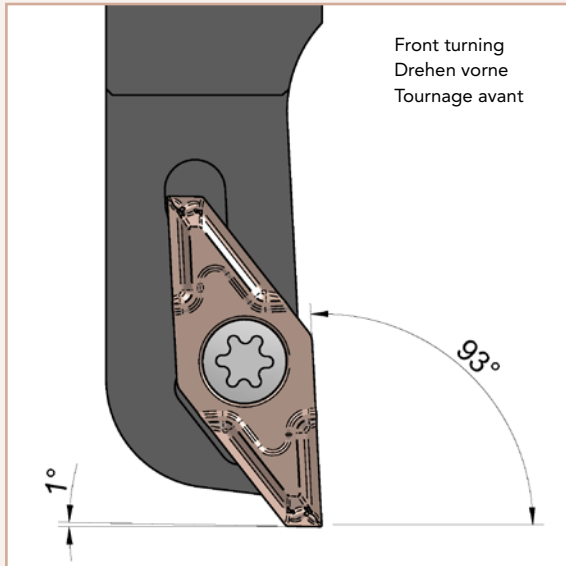

SVJP

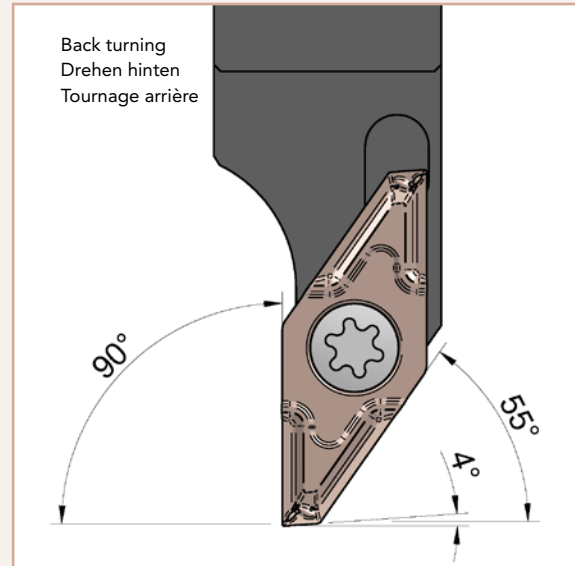

SVXP

Coating of inserts

Beschichtung der Wendepplatten

Revêtement des plaquettes

✓ = Available
 ✓ = Verfügbar
 ✓ = Disponible

Designation Bezeichnung Désignation	Description Beschreibung Description
K18	<p>Without coating K18 carbide</p> <p>Ohne Beschichtung K18 Hartmetall</p> <p>Sans revêtement Carbure K18</p>
BI40	<p>AlTi(C)N-based</p> <ul style="list-style-type: none"> • Universal coating. • High hardness. • Very smooth surface finish. • Suitable for steel and stainless steel. <p>AlTi(C)N-Basis</p> <ul style="list-style-type: none"> • Universalbeschichtung. • Hohe Schichthärte. • Sehr glatte Oberfläche. • Geeignet für Stahl und Edelstahl. <p>Base AlTi(C)N</p> <ul style="list-style-type: none"> • Revêtement universel. • Dureté élevée. • Bon glissement du copeau. • Adapté à l'acier et à l'acier inox.
BI90	<p>AlTiN-based</p> <ul style="list-style-type: none"> • Universal coating. • Good oxidation resistance. • High heat resistance. • Suitable for steel and stainless steel. <p>AlTiN-Basis</p> <ul style="list-style-type: none"> • Universalbeschichtung. • Gute Oxidationsbeständigkeit. • Hohe Hitzebeständigkeit. • Ideal für Stahl und Edelstahl. <p>BaseAlTiN</p> <ul style="list-style-type: none"> • Revêtement universel. • Bonne résistance à l'oxydation. • Haute résistance à la chaleur. • Adapté à l'acier et à l'acier inox.

Designation Bezeichnung Désignation	Description Beschreibung Description
BI100	<p>AlCrN-based</p> <ul style="list-style-type: none"> • Very high heat resistance. • High wear resistance. • Ideal for high speed machining of stainless steel. <p>AlCrN-Basis</p> <ul style="list-style-type: none"> • Sehr hohe Hitzebeständigkeit. • Hohe Verschleissfestigkeit. • Ideal für das Bearbeiten von Edelstahl mit hoher Schnittgeschwindigkeit. <p>Base AlCrN</p> <ul style="list-style-type: none"> • Très haute résistance à la chaleur. • Haute résistance à l'usure. • Idéal pour l'usinage à haute vitesse de coupe de l'acier inox.
BI110	<p>AlTiCrN-based</p> <ul style="list-style-type: none"> • Very smooth surface finish. • High heat resistance. • High wear resistance. • Especially suitable for machining pure copper, CuBe, CoCr and aluminium. <p>AlTiCrN-Basis</p> <ul style="list-style-type: none"> • Sehr glatte Oberfläche. • Hohe Hitzebeständigkeit. • Hohe Verschleissfestigkeit. • Besonders geeignet für die Bearbeitung von reinem Kupfer, CuBe, CoCr und Aluminium. <p>Base AlTiCrN</p> <ul style="list-style-type: none"> • Très bon glissement du copeau. • Haute résistance à la chaleur. • Haute résistance à l'usure. • Particulièrement adapté à l'usinage du cuivre pur, du CuBe, du CoCr et de l'aluminium.

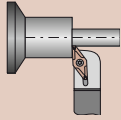

Front turning
 Drehen vorne
 Tournage avant

R / L : Right / Left machining
 R / L : Rechte / Linke Bearbeitung
 R / L : Usinage à droite / gauche

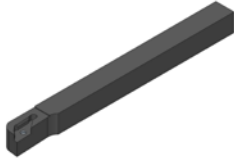
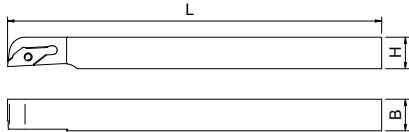
SVJP R ...	Right tool holder, reinforced version Werkzeughalter rechts, verstärkte Ausführung Porte-outil à droite, version renforcée	B	H	L	Article nr. Artikel Nr. N° Article
		8	8	120	SVJP R 0808 K10
		8	12	120	SVJP R 0812 K10
		10	10	120	SVJP R 1010 K10
		12	12	120	SVJP R 1212 K10
		16	16	120	SVJP R 1616 K10
		20	20	100	SVJP R 2020 H10
		9,52	9,52 (3/8")	120	SVJP R 952 K10
		12,7	9,52 (1/2")	120	SVJP R 127 K10
				for inserts R	für Wendeplatten R

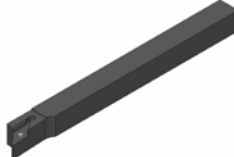
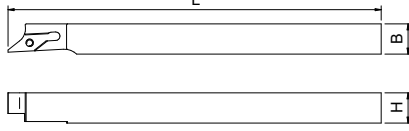

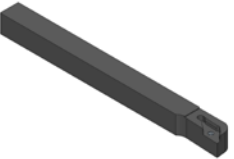
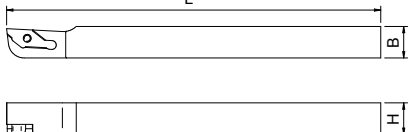
SVJP RA ...	Right tool holder, cleared version Werkzeughalter rechts, freigestellte Ausführung Porte-outil à droite, version dégagée	B	H	L	Article nr. Artikel Nr. N° Article
		10	10	120	SVJP RA 1010 K10
		12	12	120	SVJP RA 1212 K10
				for inserts R	für Wendeplatten R

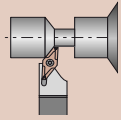

SVJP L ...	Left tool holder Werkzeughalter links Porte-outil à gauche	B	H	L	Article nr. Artikel Nr. N° Article
		8	6	120	SVJP L 0806 K10
		8	7	120	SVJP L 0807 K10
		8	8	120	SVJP L 0808 K10
		10	8	120	SVJP L 1008 K10
		10	10	120	SVJP L 1010 K10
		12	12	120	SVJP L 1212 K10
		16	16	120	SVJP L 1616 K10
				for inserts L	für Wendeplatten L

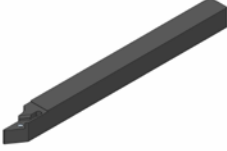

Back turning
 Drehen hinten
 Tournage arrière

R / L : Right / Left machining
 R / L : Rechte / Linke Bearbeitung
 R / L : Usinage à droite / gauche

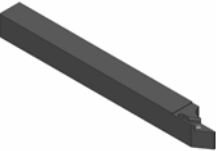
SVXP R ...	Right tool holder Werkzeughalter rechts Porte-outil à droite	B	H	L	Article nr. Artikel Nr. N° Article
		10	10	120	SVXP R 1010 K10
		12	12	120	SVXP R 1212 K10
		16	16	120	SVXP R 1616 K10
		for inserts L		für Wendepplatten L	pour plaquettes L

SVXP L ...	Left tool holder Werkzeughalter links Porte-outil à gauche	B	H	L	Article nr. Artikel Nr. N° Article
		12	12	120	SVXP L 1212 K10
		for inserts R		für Wendepplatten R	pour plaquettes R

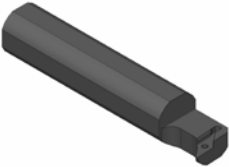
Cylindrical turning tool holders for counter-operation Zylindrische Drehwerkzeughalter zur Rückseitenbearbeitung Porte-outils de tournage cylindriques pour contre-opération	
	<p>See the «Cylindrical turning tool holders» documentation for further information. Siehe die «Zylindrische Drehwerkzeughalter» Dokumentation für weitere Informationen. Voir la documentation «Porte-outils de tournage cylindriques» pour plus d'informations.</p>

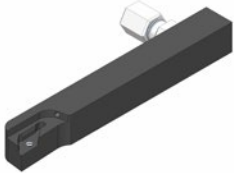
Tool holders with internal coolant Werkzeughalter mit Innenkühlung Porte-outils avec arrosage intégré	
	<p>See the «Tool holders with internal coolant» documentation for further information. Siehe die «Werkzeughalter mit Innenkühlung» Dokumentation für weitere Informationen. Voir la documentation «Porte-outils avec arrosage intégré» pour plus d'informations.</p>

001-1	Key Schlüssel Clé	Article nr. Artikel Nr. N° Article
	Torx 8	001-1

001-7	Screw for tool holder SVJP / SVXP Schraube für Werkzeughalter SVJP / SVXP Vis pour porte-outil SVJP / SVXP	Article nr. Artikel Nr. N° Article
	M2,5 x 7,5	001-7

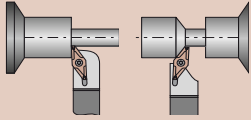

Turning
Drehen
Tournage

R / L : Right / Left machining
R / L : Rechte / Linke Bearbeitung
R / L : Usinage à droite / gauche

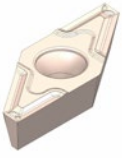
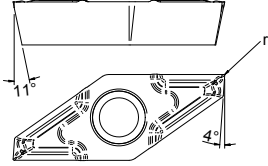
VPGT...FR	Right VPGT insert VPGT Wendeplatte rechts Plaquette VPGT à droite	r	Article nr. Artikel Nr. N° Article	K18	B140	B190	B1100	B1110
		0	VPGT 10 03 ZZ FR FW	✓	✓	✓	✓	✓
		0,08	VPGT 10 03 008 FR FW	✓	✓	✓	✓	✓
		0,2	VPGT 10 03 02 FR FW	✓	✓	✓	✓	✓
Use with SVJP R and SVXP L tool holders Verwendung mit SVJP R und SVXP L Werkzeughalter Utilisation avec les porte-outils SVJP R et SVXP L								

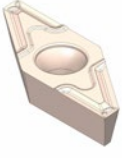
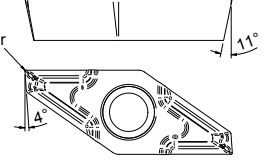
VPGT...FL	Left VPGT insert VPGT Wendeplatte links Plaquette VPGT à gauche	r	Article nr. Artikel Nr. N° Article	K18	B140	B190	B1100	B1110
		0	VPGT 10 03 ZZ FL FW	✓	✓	✓	✓	✓
		0,08	VPGT 10 03 008 FL FW	✓	✓	✓	✓	✓
		0,2	VPGT 10 03 02 FL FW	✓	✓	✓	✓	✓
Use with SVJP L and SVXP R tool holders Verwendung mit SVJP L und SVXP R Werkzeughalter Utilisation avec les porte-outils SVJP L et SVXP R								



Represented by Vertreten durch Représenté par

